

Quick Start Guide

This quick start guide describes how to install and use the 10/100BASE-TX to 100BASE-FX Media Converter. The converter introduced here provides one channel media conversion solution.

Physical Description

Product Overview

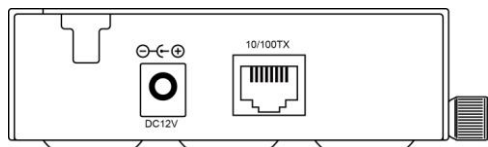

This 10/100BASE-TX to 100BASE-FX Media Converter is a plug-and-play device. Connect the supplied AC to DC power adaptor to the receptacle on the front panel of the 10/100BASE-TX to 100BASE-FX Media Converter, and then attach the plug into a standard AC outlet.

The 10/100Base-TX and 100Base-FX Connectors

The 10/100Base-TX Connection

The following lists the pinouts of 10/100Base-TX port.

Pin	Label
1	TP0+
2	TP0-
3	TP1+
4	TP2+
5	TP2-
6	TP1-
7	TP3+
8	TP3-

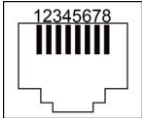

The 100Base-FX Connection

The Tx (transmit) port of device I is connected to the Rx (receive) port of device II, and the Rx (receive) port of device I to the Tx (transmit) port of device II.

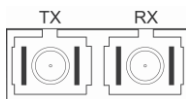

The WDM 100Base-FX Connection

Only one optical fiber is required to transmit and receive data.

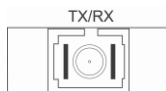

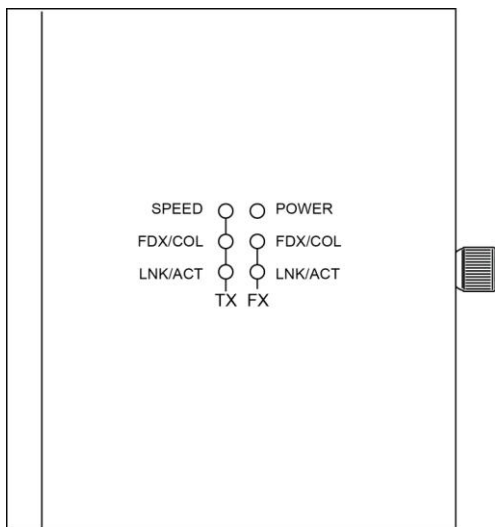
The Port Status LEDs

LEDs	State	Indication
POWER	Steady	Power on
	Off	Power off
SPEED	Steady	Connection at the speed of 100Mbps
	Off	Connection at the speed of 10Mbps
LNK/ACT	Steady	A valid network connection is established on TX port LNK stands for LINK
	Flashing	Transmitting or receiving Data ACT stands for ACTIVITY
	Off	No network connection is established
FDX/COL	Steady	Connection at Full-duplex mode FDX stands for Full-duplex
	Flashing	Collisions occur COL stands for COLLISION
	Off	Connection at Half-duplex mode

DIP Switch

No.	OFF	ON
1		TX port Force mode: 100Mbps
2		TX port Force mode: 10Mbps
3		TX port Force mode: Full duplex mode
4		TX port Force mode: Half duplex mode
5	Active auto-negotiation for TX port	Provides mandatory speed for TX port
6	Active LPT (Link Pass Through)	Inactive LPT

<Note> Power must be off/on after re-setting LPT function.

Functional Description

- Complies with IEEE802.3 10BASE-T, 802.3u 100BASE-TX, 100BASE-FX
- Built-in Fiber Tray, for ease of fiber cable management and installation Auto-Negotiation
- Auto-MDI/MDIX
- Supports IEEE802.3x Flow controls: Flow control for full duplex and Back pressure for half duplex
- Supports Link-Fault-Pass-Through
- Full wire-speed forwarding rate
- Operating voltage and Max. current consumption: 0.25A @ 12VDC. Power consumption: 3W Max.
- Power Supply: 12VDC external universal PSU.
- 0°C to 50°C (32°F to 122°F) operating temperature range.

FCC Statement

The FCC (Federal Communications Commission) restricts the amount of radio frequency emission and radiation coming from computer equipment.

The equipment introduced in this manual has been tested and found to comply with the limits for a Class A digital device pursuant to Part 15 of the FCC rules. These limits are designed to provide reasonable protection against harmful interference when the equipment is operated in a commercial environment.

This equipment generates, uses, and can radiate radio frequency energy, and if not installed and used in accordance with the instruction manual, may cause harmful interference to radio communications.

Operation of this equipment in a residential area is likely to cause harmful interference in which case the user is required to correct the interference at his/her own expense.

Any changes or modifications not expressly approved by the manufacture would void the user's authority to operate the equipment.

Trademarks

Product names mentioned in this manual may be trademarks or registered trademarks of those products.

All trademarks or brand names mentioned are properties of their respective companies.

Preface

This manual describes how to install and use the 10/100BASE-TX to 100BASE-FX Media Converter. The Converter introduced here provides one channel media conversion solution:

10/100Base-TX to 100Base-FX with link-fault-pass-through function

The 10/100BASE-TX to 100BASE-FX Media Converter fully complies with IEEE802.3 10BASE-T, 802.3u 100BASE-TX, 100BASE-FX Ethernet standards.

In this manual, you will find:

- Product overview
- Features on the media converter
- Illustrative LED functions
- Installation instructions
- Specifications

Table of Contents

Quick Start Guide	1
Physical Description.....	1
Functional Description	3
FCC Statement	4
Trademarks	4
Preface	4
Table of Contents	5
Introduction	6
Product Overview.....	6
Product Features	6
Packing List	6
One-Channel Media Converter	7
Physical Ports	7
Port Status LEDs	7
DIP Switch	8
Installation	9
Selecting a Site for the Equipment.....	9
Cable Management Tray	9
Connecting to Power.....	11
Specifications	12

Introduction

The 10/100BASE-TX to 100BASE-FX Media Converter provides one channel for media conversion between 10/100Base-TX to 100Base-FX with link-fault-pass-through function.

Product Overview

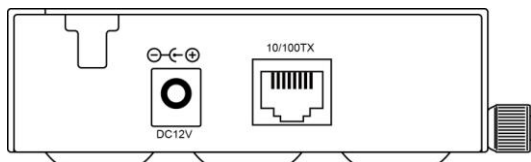

Figure 1:
10/100BASE-TX to 100BASE-FX Media Converter with link-fault-pass-through function

Product Features

- Complies with IEEE802.3 10BASE-T, 802.3u 100BASE-TX, 100BASE-FX
- Built-in Fiber Tray, for ease of fiber cable management and installation Auto-Negotiation
- Auto-MDI/MDIX
- Supports IEEE802.3x Flow controls: Flow control for full duplex and Back pressure for half duplex
- Supports Link-Fault-Pass-Through
- Full wire-speed forwarding rate
- Operating voltage and Max. current consumption: 0.25A @ 12VDC. Power consumption: 3W Max.
- Power Supply: 12VDC external universal PSU.
- 0°C to 50°C (32°F to 122°F) operating temperature range.

Packing List

When you unpack this product package, you will find the items listed below. Please inspect the contents, and report any apparent damage or missing items immediately to your authorized reseller.

- The Media Converter
- User's Manual
- AC to DC Power Adaptor

One-Channel Media Converter

Physical Ports

10/100BASE-TX to 100BASE-FX Media Converter

This converter provides one 10/100Base-TX port and one 100Base-FX fiber port. For the 100Base-FX fiber port, it provides options of multi-mode/single-mode or WDM multi-mode/single-mode fiber. For the 10/100Base-TX port, it uses RJ-45 connector and supports auto MDIX for uplink purpose.

Port Status LEDs

The LED indicators give you instant feedback on status of the converter:

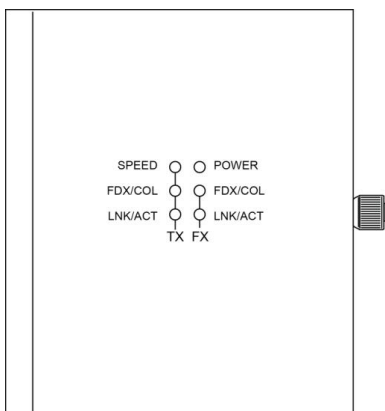

Figure 2:
10/100BASE-TX to 100BASE-FX Media Converter with link-fault-pass-through function

LEDs	State	Indication
POWER	Steady	Power on
	Off	Power off
SPEED	Steady	Connection at the speed of 100Mbps
	Off	Connection at the speed of 10Mbps
LNK/ACT	Steady	A valid network connection is established on TX port LNK stands for LINK
	Flashing	Transmitting or receiving Data ACT stands for ACTIVITY
	Off	No network connection is established
FDX/COL	Steady	Connection at Full-duplex mode FDX stands for Full-duplex
	Flashing	Collisions occur COL stands for COLLISION
	Off	Connection at Half-duplex mode

DIP Switch

No.	OFF	ON
1		TX port Force mode: 100Mbps
2		TX port Force mode: 10Mbps
3		TX port Force mode: Full duplex mode
4		TX port Force mode: Half duplex mode
5	Active auto-negotiation for TX port	Provides mandatory speed for TX port
6	Active LPT (Link Pass Through)	Inactive LPT

<Note> Power must be off/on after re-setting LPT function.

Installation

This chapter gives step-by-step installation instructions for the Converter.

Selecting a Site for the Equipment

As with any electric device, you should place the equipment where it will not be subjected to extreme temperatures, humidity, or electromagnetic interference. Specifically, the site you select should meet the following requirements:

- The ambient temperature should be between 32 and 122 degrees Fahrenheit (0 to 50 degrees Celsius).
- The relative humidity should be less than 95 percent, non-condensing.
- Surrounding electrical devices should not exceed the electromagnetic field (RFC) standards for IEC 801-3, Level 2 (3V/M) field strength.
- Make sure that the equipment receives adequate ventilation. Do not block the ventilation holes of the equipment.
- The power outlet should be within 1.8 meters of the product.

Cable Management Tray

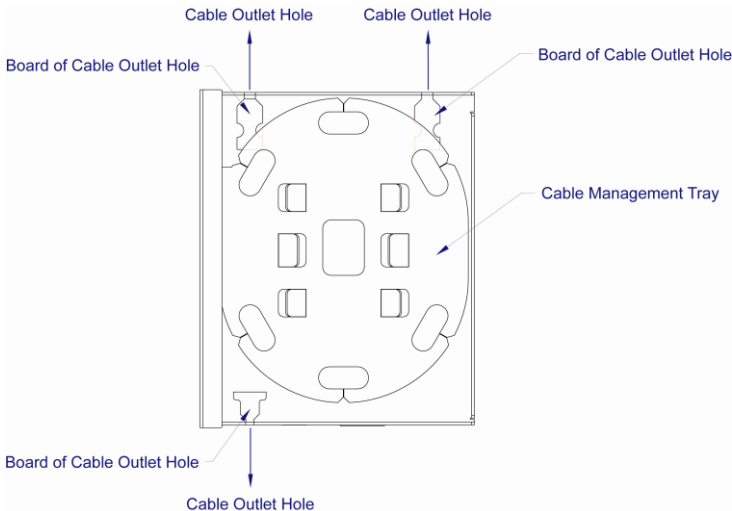

Cable management tray, board of cable outlet hole, and cable outlet hole.

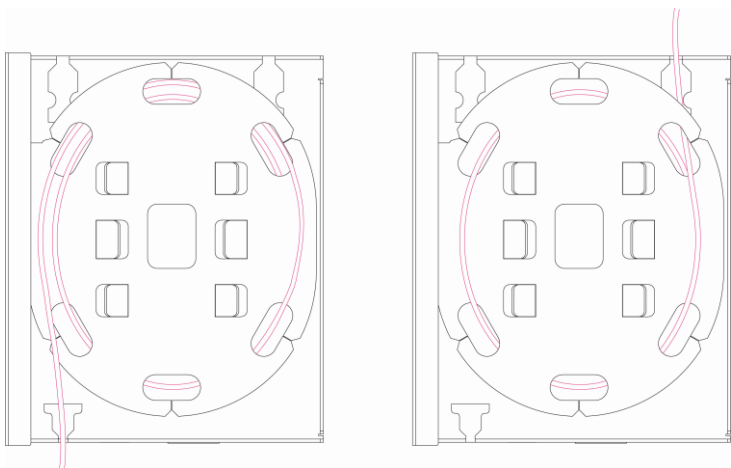

Route the fiber cable.

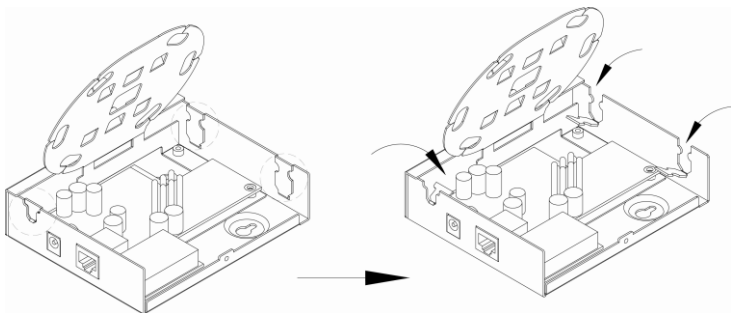

Bend the board of cable outlet hole.

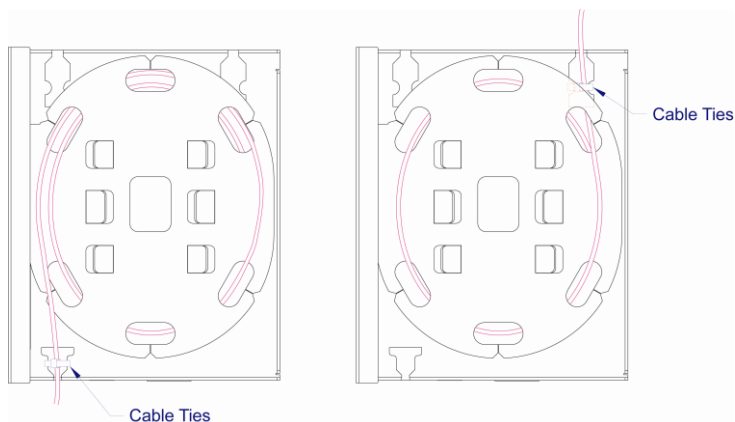

Cable ties.

Connecting to Power

This Converter is a plug-and-play device.

Connect the supplied AC to DC power adapter to the receptacle on the front panel of the converter. Attach the plug into a standard AC outlet.

Specifications

Applicable Standards	IEEE802.3 10Base-T IEEE802.3u 100Base-TX, 100Base-FX IEEE802.3x
Fixed Ports 10/100Base-TX to 100Base-FX:	1 10/100Base-TX port 1 100Base-FX port
Speed 10Base-T 100Base-TX 100Base-FX	10/20Mbps for half/full-duplex 100/200Mbps for half/full-duplex
Forwarding rate	14,880pps for 10Mbps 148,810pps for 100Mbps
LED Indicators	Unit: POWER TX port: SPEED, FDX/COL, LNK/ACT FX port: FDX/COL, LNK/ACT
Dimensions	100mm (W) × 122mm (D) × 32.5mm (H) (3.94" (W) × 4.8" (D) × 1.28" (H))
Weight	0.5Kg (1.1lbs.)
Power Consumption	3W Max. 0.25A @ 12VDC
Operating Temperature	0°C ~ 50°C (32 ~ 122°F)
Storage Temperature	-20°C ~ 70°C (-4°F ~ 158°F)
Humidity	5 ~ 95%, non-condensing
Emissions	CE Mark Class A FCC part 15 Class A VCCI Class A