

Quick Start Guide

This quick start guide describes how to install and use the Ethernet Extender over coaxial cable. This is the Ethernet Extender of choice for environments constrained by space.

Installation

ED3238T (Transmitter): This is a PoL (Power over Link) transmitter. Data and power can be delivered at the same time through a coaxial cable to turn on and communicate with ED3238R (Receiver) via BNC interface.

ED3238R (Receiver): This is a PoL (Power over Link) Receiver. ED3238R (Receiver) can be powered by ED3238T (Transmitter) through a coaxial cable. The Ethernet port of ED3238R (Receiver) supports IEEE802.3af PoE/PSE for fulfilling PoE/PD application.

Physical Description

The Port Status LEDs and Power Inputs

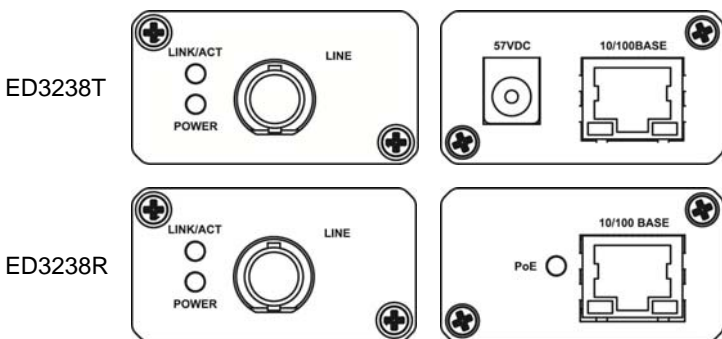

LEDs	State	Indication	
POWER	Steady	Power received	
	Off	Power off	
LINK/ACT	Steady	A valid Extender connection established	
	Flashing	Data transmission or receiving	
	Off	Extender connection is not established	
PoE	Steady	Powered device (PD) is connected	
	Off	Powered device (PD) is disconnected	
	Green	Steady	A valid Ethernet connection established
		Flashing	Data transmission or receiving
		Off	No valid Ethernet connection established
	Yellow	Steady	Link speed at 100Mbps
		Off	Link speed at 10Mbps

10/100Base-TX Connectors

10/100Base-TX Connection
The following lists the pinouts of 10/100Base-TX RJ-45 port.

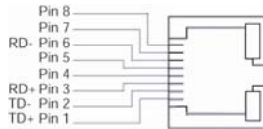

Pin	Regular Port	PoE Port
1	Output Transmit Data +	Output Transmit Data +
2	Output Transmit Data -	Output Transmit Data -
3	Input Receive Data +	Input Receive Data +
4		Positive (VCC+)
5		Positive (VCC+)
6	Input Receive Data -	Input Receive Data -
7		Negative (VCC-)
8		Negative (VCC-)

Functional Description

- Ethernet port: Supports IEEE802.3/802.3u/802.3x. Auto-negotiation: 10/100Mbps, full/half-duplex. Auto MDI/MDIX.
- BNC interface: 100Mbps full-duplex throughput for Power over Link (PoL) application runs up to 250 meters on RG11 and 180 meters on RG6 coaxial cables.
- Operating temperature range @ -10°C to 50°C (14°F to 122°F).
- ED3238T:
 - Can be PoE/PD powered by IEEE802.3at PoE/PSE device through Ethernet port of ED3238T or can be powered by

- 57VDC power adapter through DC Jack interface of ED3238T.
 - Input Power Rating (optional): DC Jack: 57VDC, 0.52A minimum; PoE connector: 50-57VDC, 0.52A minimum.
- ED3238R PSE port: 15.4 Watts.

FCC Warning

This device complies with Part 15 of the FCC Rules. Operation is subject to the following two conditions:

(1) this device may not cause harmful interference, and (2) this device must accept any interference received, including interference that may cause undesired operation.

CE Mark Warning

This is a Class A product. In a domestic environment, this product may cause radio interference in which case the user may be required to take adequate measures.

Preface

This manual describes how to install and use the Ethernet Extender. The Ethernet Extender introduced here provides one channel for Ethernet over coaxial cable.

The Ethernet Extender fully complies with IEEE802.3 10Base-T and IEEE802.3u 100Base-TX standards.

In this manual, you will find:

- Product overview
- Features on the Ethernet Extender
- Illustrative LED functions
- Installation instructions
- Specifications

Table of Contents

Quick Start Guide	1
<i>Installation.....</i>	<i>1</i>
<i>Physical Description</i>	<i>1</i>
The Port Status LEDs and Power Inputs.....	1
10/100Base-TX Connectors.....	2
<i>Functional Description.....</i>	<i>2</i>
FCC Warning	4
CE Mark Warning	4
Preface.....	4
Table of Contents	5
Introduction	6
<i>Product Overview.....</i>	<i>6</i>
<i>Product Features.....</i>	<i>6</i>
<i>Packing List.....</i>	<i>6</i>
One-Channel Ethernet Extender	7
<i>Ports</i>	<i>7</i>
<i>Front Panel & LEDs</i>	<i>7</i>
LED Indicators.....	7
10/100Base-TX Connectors.....	8
Installation	9
<i>Selecting a Site for the Equipment.....</i>	<i>9</i>
<i>Connecting to Power</i>	<i>10</i>
10/100Base-TX Port	10
57VDC DC Jack	10
Specifications	11

Introduction

The Ethernet Extender provides one channel for Ethernet over coaxial cable. This Ethernet Extender solution is perfectly fitted in the environments constrained by space.

Product Overview

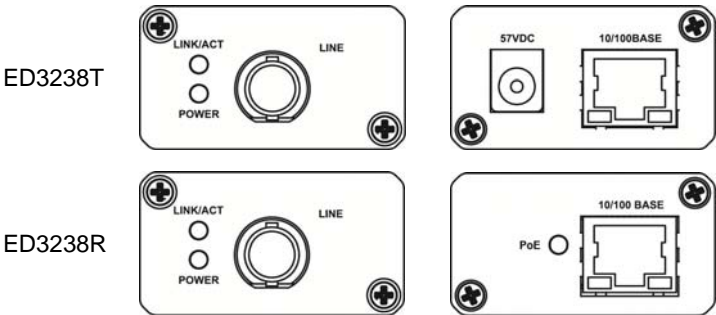

Product Features

- Ethernet port: Supports IEEE802.3/802.3u/802.3x. Auto-negotiation: 10/100Mbps, full/half-duplex. Auto MDI/MDIX.
- BNC interface: 100Mbps full-duplex throughput for Power over Link (PoL) application runs up to 250 meters on RG11 and 180 meters on RG6 coaxial cables.
- Operating temperature range @ -10°C to 50°C (14°F to 122°F).
- ED3238T:
 - Can be PoE/PD powered by IEEE802.3at PoE/PSE device through Ethernet port of ED3238T or can be powered by 57VDC power adapter through DC Jack interface of ED3238T.
 - Input Power Rating (optional): DC Jack: 57VDC, 0.52A minimum; PoE connector: 50-57VDC, 0.52A minimum.
- ED3238R PSE port: 15.4 Watts.

Packing List

When you unpack this product package, you will find the items listed below. Please inspect the contents, and report any apparent damage or missing items immediately to our authorized reseller.

- The Ethernet Extender
- User's Manual
- AC to DC Power Adaptor

One-Channel Ethernet Extender

Ports

The Ethernet Extender provides TX ports and one Ethernet Extender port.

For the TX ports, it uses RJ-45 connector and auto senses the speed of 10/100Mbps.

For the Ethernet Extender port, it uses BNC connectors and the Ethernet extension expected performance: 100Mbps full-duplex throughput for Power over Link (PoL) application runs up to 250 meters on RG11 and 180 meters on RG6 coaxial cables.

Front Panel & LEDs

LED Indicators

The LED indicators give you instant feedback on status of the Ethernet Extender:

LEDs	State	Indication		
POWER	Steady	Power received		
	Off	Power off		
LINK/ACT	Steady	A valid Extender connection established		
	Flashing	Data transmission or receiving		
	Off	Extender connection is not established		
PoE	Steady	Powered device (PD) is connected		
	Off	Powered device (PD) is disconnected		
	Green	Steady	A valid Ethernet connection established	
		Flashing	Data transmission or receiving	
		Off	No valid Ethernet connection established	
	Yellow	Steady	Link speed at 100Mbps	
		Off	Link speed at 10Mbps	

10/100Base-TX Connectors

10/100Base-TX Connection

The following lists the pinouts of 10/100Base-TX RJ-45 port.

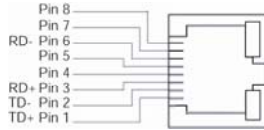

Pin	Regular Port	PoE Port
1	Output Transmit Data +	Output Transmit Data +
2	Output Transmit Data -	Output Transmit Data -
3	Input Receive Data +	Input Receive Data +
4		Positive (VCC+)
5		Positive (VCC+)
6	Input Receive Data -	Input Receive Data -
7		Negative (VCC-)
8		Negative (VCC-)

Installation

This chapter gives installation instructions for the Ethernet Extender.

- ED3238T needs to be powered by 57VDC power adapter. Then ED3238T (as PoE/PD) would have at least 55VDC power input.
- RG6: 30-180M, RG11: 50-250M.
- ED3238T can only used with ED3238R. Other products might get damaged if connected with ED3238T.
- We suggest the user to connect the grounding wires (shipped with shipping package) to ED3238T and ED3238R before using ED3238T and ED3238R.

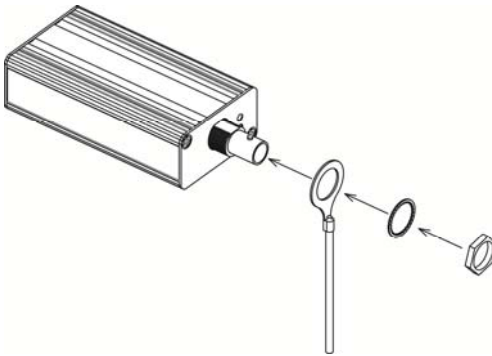

Selecting a Site for the Equipment

As with any electric device, you should place the equipment where it will not be subjected to extreme temperatures, humidity, or electromagnetic interference. Specifically, the site you select should meet the following requirements:

- The Surrounding Air temperature should be between -10 to 50 degrees Celsius.
- The relative humidity should be less than 95 percent, non-condensing.
- Surrounding electrical devices should not exceed the electromagnetic field (RFC) standards.
- Make sure that the equipment receives adequate ventilation. Do not block the ventilation holes of the equipment.
- The power outlet should be within 1.8 meters of the product.
- Warning: "The equipment is designed for building installation and not intended to be connected to exposed (outside plant) networks including campus environment." or equivalent.

Connecting to Power

10/100Base-TX Port

- ED3238T can be PoE/PD powered by IEEE802.3at PoE/PSE device through Ethernet port of ED3238T.

57VDC DC Jack

- Connect the supplied AC to DC power adapter to the DC Jack of ED3238T.
- Connect the plug of AC to DC power adapter into a standard AC outlet with the appropriate AC voltage.

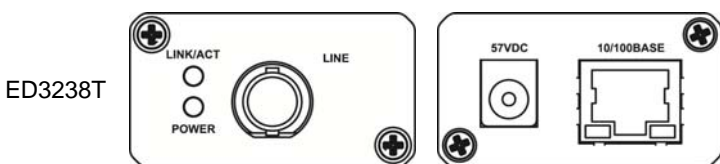

Specifications

Applicable Standards	IEEE802.3 10Base-T, IEEE802.3u 100Base-TX
Fixed Ports	1 x 10/100Mbps Ethernet port with RJ-45 connector 1 x Ethernet Extender port with BNC interface
Speed 10Base-T 100Base-TX Ethernet Extender	10/20Mbps for half/full-duplex 100/200Mbps for half/full-duplex 100Mbps
Switching Method	Store-and-Forward
Forwarding rate	14,880/148,810pps for 10/100Mbps
Cable 10Base-T 100Base-TX Ethernet Extender	4-pair UTP/STP Cat. 3, 4, 5 up to 100m 4-pair UTP/STP Cat. 5 up to 100m Coaxial cable
LED Indicators	Per Unit (4 LEDs)- POWER, LINK/ACT (BNC), LINK/ACT (RJ-45), SPEED (RJ-45) ED3238R- PoE
Dimensions	54.2mm (W) x 80.3mm (D) x 21.9mm (H) (2.13" (W) x 3.16" (D) x 0.86" (H))
Weight	100g (0.22lb.)
Power	DC Jack Power Inputs: 0.52A @ 57VDC, External AC/DC required
Operating Temperature	-10°C ~ 50°C (14°F ~ 122°F)
Storage Temperature	-30°C ~ 70°C (-22°F ~ 158°F)
Humidity	5 ~ 95%, non-condensing
Safety	UL60950-1
Emission	FCC Part 15 Class A, CE Mark Class A