

1 Unpacking

Open the carton and unpack the items. Your package should include:

- EX77000 Ethernet switch
- Rack mounting brackets

If any items are missing or damaged, notify your EtherWAN representative. If possible, save the carton and packing material in case you need to ship or store the switch in the future.

2 What Else You Need

- Appropriate cables for data ports
- Personal computer or laptop

3 Select a Location

- Desktop installations: Mount on a flat table or shelf surface.
- Rack installations: Use a 19-inch (48.3-centimeter) EIA standard equipment rack that is grounded and physically secure.
- Identify a power source within 6 feet (1.8 meters).
- Choose a dry area with ambient temperature between -40 and 75°C (-40 and 167°F).
- Keep away from heat sources, sunlight, warm air exhausts, hot-air vents, and heaters.
- Be sure there is adequate airflow.
- Keep the switch at least 6 ft (1.83 m) away from the nearest source of electromagnetic noise, such as a photocopy machine.

4 Connect to the Data Ports

Depending on the model, your switch can have the following ports:

- 0, 8, 16, or 24 10/100Base-TX ports
- 0, 8, 16, or 24 100Base-FX ports
- 4 Gigabit ports

10/100Base-TX and 100Base-FX Ports

These ports come in 10/100Base-TX and 100Base-FX/SFP interfaces. They can connect to devices such as an IP surveillance camera or a Voice Over Internet Protocol (VoIP) phone.

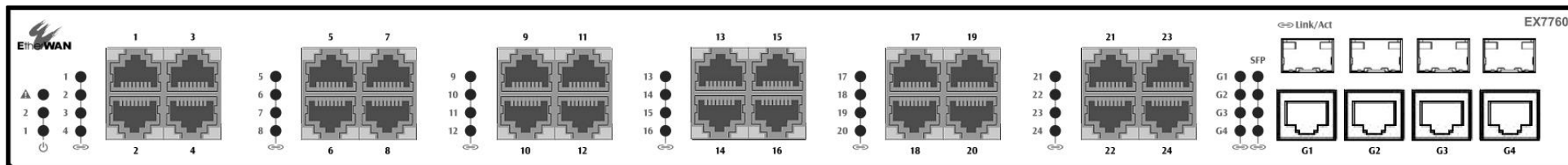
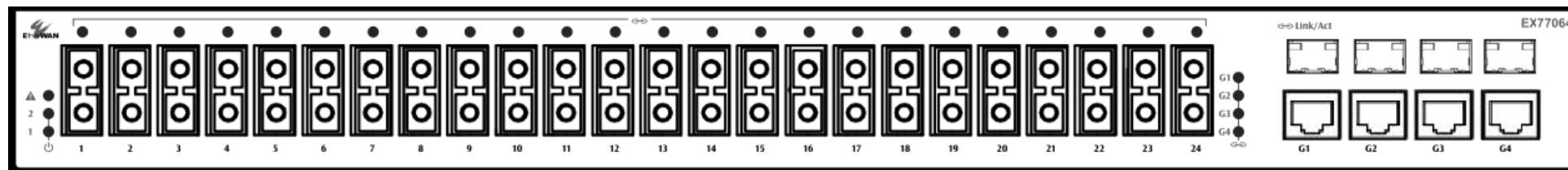

Gigabit Ports

Some switch models have 4-port 1000Base-SX/LX/BX ports, or 4-port 1000Base SFP-combo with 10/100/1000Base-TX ports. These ports can connect to network devices such as a computer, printer, network video recorder (NVR), network storage, or they can connect to the network itself.

Gigabit-SFP combo ports operate in “either/or” fashion. This means that attaching to a 1 Gbps SFP port renders the equivalent partner combo port unavailable.

5 Apply AC Power

If your EX77000 comes with AC power cables, connect the cables into the power modules at the back of the switch. If your switch comes with a DC or AC terminal block (no cable), then connect the switch to a suitable power supply using 12 to 18 AWG wire. Redundant power supply is supported. However, only one power input is required to operate the switch. Input voltage is 48 VDC or 100 – 240 VAC / 88-300 VDC, depending on model.

Relay Output Alarm

The switch provides one dry contact for signaling of a user-defined power or port failure. The alarm relay default is “open” and forms a closed circuit when the event occurs. The relay output can be connected to an alarm signaling device. Relay output current is 30VDC / 0.6A.

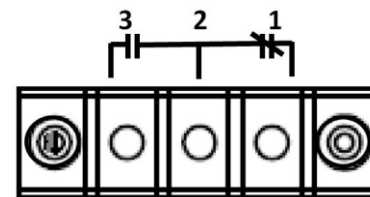

Power-Up Sequence

When you apply power:

- All **Link/ACT** LEDs blink momentarily.
- The **System** LED goes ON.
- LEDs for every port connected to a device flash.

6 Front Panel LEDs

LED	Color	Status
Power	Green	On: Power on
		Off: Power off
Alarm	Red	Link down or power down
10/100Base-TX, 100Base-FX/BX/SFP		
Link/Act	Green	On: Network connection established
		Flashing: Port sending or receiving data
1000Base-T/SX/LX/SFP		
Link/Act	Green	On: Network connection established
		Flashing: Port sending or receiving data

7 Console Configuration

Connect to the switch console by connecting the DB-9 cable to the console port of the switch and to the serial port of the computer running a terminal emulation application (such as HyperTerminal or Putty).

Configuration settings of the terminal-emulation program: Baud rate: 115,200bps, Data bits: 8, Parity: none, Stop bit: 1, Flow control: none.

The default login name is `root`, no password.

8 Web Configuration

Log in to the switch by launching a web browser and entering `192.168.1.10` in the address bar. Enter the default login ID: `root` (no password) and click “Login.”

9 Other Electrical and Safety Information

(A) Elevated Operating Ambient - If installed in a closed or multi-unit rack assembly, the operating ambient temperature of the rack environment may be greater than room ambient. Therefore, consideration should be given to installing the equipment in an environment compatible with the maximum ambient temperature (T_{ma}).

B) Mechanical Loading - Mounting of the equipment in the rack should be such that a hazardous condition is not achieved due to uneven mechanical loading.

C) Circuit Overloading - Consideration should be given to the connection of the equipment to the supply circuit and the effect that overloading of the circuits might have on overcurrent protection and supply wiring. Appropriate consideration of equipment nameplate ratings should be used when addressing this concern.

D) Reliable Earthing - Reliable earthing of rack-mounted equipment should be maintained. Particular attention should be given to supply connections other than direct connections to the branch circuit (e.g. use of power strips).

Do not disable the power cord grounding plug. The grounding plug is an important safety feature.

Caution:

This equipment shall be used with all power supplies connected simultaneously.



Hazardous voltages may occur within this unit when connected to all power supplies. Prevent access to hazardous voltages by disconnecting this equipment from all power supplies.



Plug the power cord into a grounded (earthed) electrical outlet that is easily accessible at all times.

This equipment is intended to be used in a restricted access location and by qualified personnel. This equipment is not suitable for use in locations where children are likely to be present.

Les matériels sont destinés à être installés dans des EMPLACEMENTS À ACCÈS RESTREINT.

This equipment must be connected to Protective earthing (PE) to AC mains ground. The protective earthing conductor shall be minimum 18 AWG and having green-and-yellow insulation. The thread diameter of screw type terminal shall be minimum 3.5mm.

The ground wire should be installed first (earlier than live and neutral wires) and then removed. The grounding wire should be longer than live and neutral wires.

When wiring the switch to power, unscrew the two retaining screws that hold the protective cover in place. The metal protective cover should be reattached after the wiring is completed to avoid the danger of electric shock.

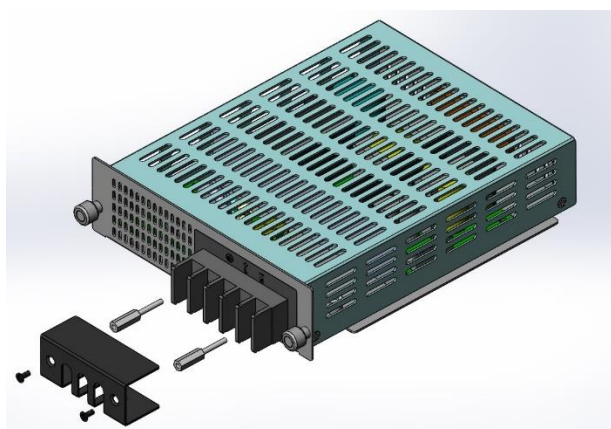

When stripping the cable sheath for connection to the terminal block, leave only 10mm of wires exposed for the connection.

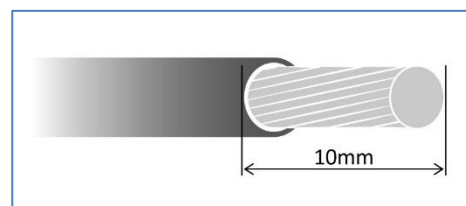

The power cord shall be IEC 60227 certified, rated 0.75 mm² x 3C or UL recognized minimum 18AWG.

Terminal Block:

This product is intended to be supplied by certified DC power source and rated output rating: 48 VDC, 0.8 A minimum.

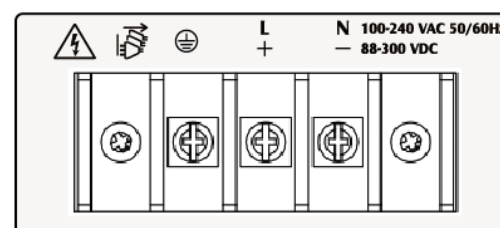
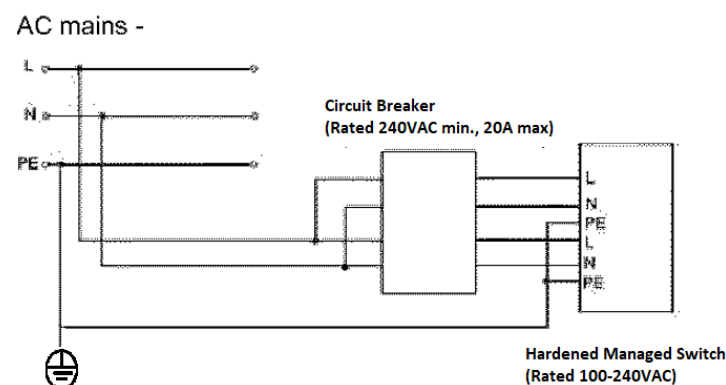
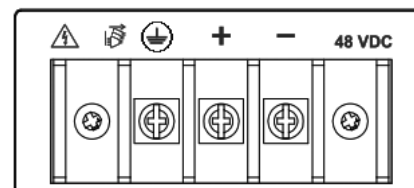

AC Terminal Block

AC power rating current is 0.8A. All power connection wiring by a qualified electrician in accordance with National Electrical Code, ANSI/NFPA 70 and Canadian Electrical Code, Part I, CSA C22.1. An IEC certified or UL listed single-phase type circuit-breaker, rated maximum 20A, shall be installed between mains circuit and equipment.

Thumbscrews should be tightened with a tool after both initial installation subsequent access to the panel.

Note:

This equipment must use UL recognized Laser Class 1 optical transceiver.

Manufacturer information:

EtherWAN Systems, Inc.

33F, No. 93, Sec. 1, Xintai 5th Rd., Xizhi Dist., New Taipei City, 221 Taiwan

The full product manual can be downloaded from:
www.etherwan.com

